

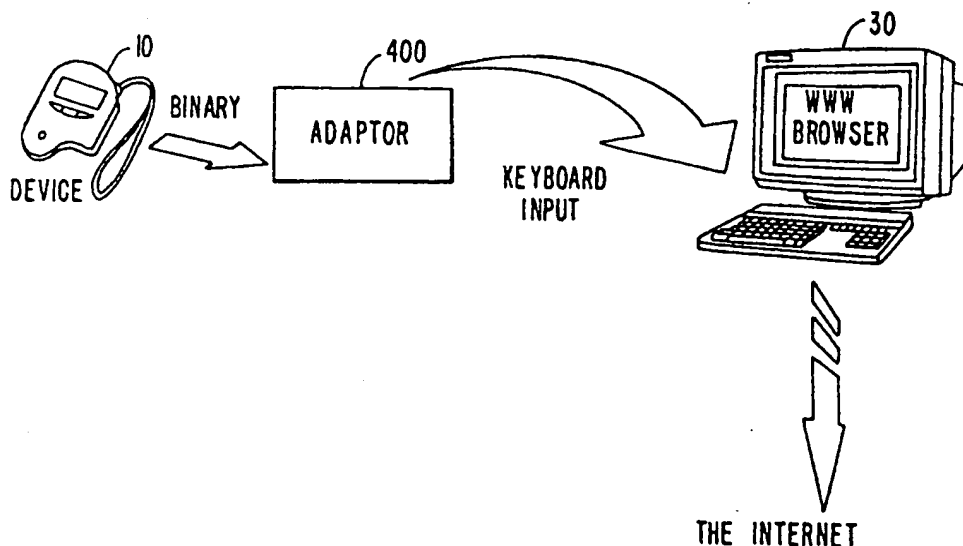

INTERNATIONAL APPLICATION PUBLISHED UNDER THE PATENT COOPERATION TREATY (PCT)

<p>(51) International Patent Classification ⁶ : H04M 11/00</p>	<p>A1</p>	<p>(11) International Publication Number: WO 98/59487 (43) International Publication Date: 30 December 1998 (30.12.98)</p>
<p>(21) International Application Number: PCT/US98/13136 (22) International Filing Date: 23 June 1998 (23.06.98)</p> <p>(30) Priority Data: 60/050,528 23 June 1997 (23.06.97) US 09/102,535 22 June 1998 (22.06.98) US</p> <p>(71) Applicant: ENACT HEALTH MANAGEMENT SYSTEMS [US/US]; Suite 306, 1975 El Camino Real West, Mountain View, CA 94040-2218 (US).</p> <p>(72) Inventor: TACKLIND, Christopher, A.; 250 Cowper Street, Palo Alto, CA 94301 (US).</p> <p>(74) Agents: GRAY, Gerald, T. et al.; Townsend and Townsend and Crew LLP, 8th floor, Two Embarcadero Center, San Francisco, CA 94111-3834 (US).</p>	<p>(81) Designated States: AL, AM, AT, AU, AZ, BA, BB, BG, BR, BY, CA, CH, CN, CU, CZ, DE, DK, EE, ES, FI, GB, GE, GH, GM, GW, HU, ID, IL, IS, JP, KE, KG, KP, KR, KZ, LC, LK, LR, LS, LT, LU, LV, MD, MG, MK, MN, MW, MX, NO, NZ, PL, PT, RO, RU, SD, SE, SG, SI, SK, SL, TJ, TM, TR, TT, UA, UG, UZ, VN, YU, ZW, ARIPO patent (GH, GM, KE, LS, MW, SD, SZ, UG, ZW), Eurasian patent (AM, AZ, BY, KG, KZ, MD, RU, TJ, TM), European patent (AT, BE, CH, CY, DE, DK, ES, FI, FR, GB, GR, IE, IT, LU, MC, NL, PT, SE), OAPI patent (BF, BJ, CF, CG, CI, CM, GA, GN, ML, MR, NE, SN, TD, TG).</p> <p>Published <i>With international search report.</i></p>	

(54) Title: IMPROVED SYSTEM FOR DOWNLOADING AND REPORTING MEDICAL INFORMATION



(57) Abstract

A system for transferring binary medical files from remote devices (10) to a central database over the internet includes an adaptor (400) for converting the binary medical information file to a compatible file of keystroke codes. The keystroke codes are transferred to a computer (30) which converts the codes to ASCII characters which are input by an applet, and transferred to the central database. Software at the central database recovers the original binary medical information file. Additionally, a system for accessing medical reports in real time utilizes a report requesting data. The codes and data are transferred over the internet to a host computer which generates a report file, and transfers the file via internet to the requestor to be displayed on a computer.

FOR THE PURPOSES OF INFORMATION ONLY

Codes used to identify States party to the PCT on the front pages of pamphlets publishing international applications under the PCT.

AL	Albania	ES	Spain	LS	Lesotho	SI	Slovenia
AM	Armenia	FI	Finland	LT	Lithuania	SK	Slovakia
AT	Austria	FR	France	LU	Luxembourg	SN	Senegal
AU	Australia	GA	Gabon	LV	Latvia	SZ	Swaziland
AZ	Azerbaijan	GB	United Kingdom	MC	Monaco	TD	Chad
BA	Bosnia and Herzegovina	GE	Georgia	MD	Republic of Moldova	TG	Togo
BB	Barbados	GH	Ghana	MG	Madagascar	TJ	Tajikistan
BE	Belgium	GN	Guinea	MK	The former Yugoslav Republic of Macedonia	TM	Turkmenistan
BF	Burkina Faso	GR	Greece	ML	Mali	TR	Turkey
BG	Bulgaria	HU	Hungary	MN	Mongolia	TT	Trinidad and Tobago
BJ	Benin	IE	Ireland	MR	Mauritania	UA	Ukraine
BR	Brazil	IL	Israel	MW	Malawi	UG	Uganda
BY	Belarus	IS	Iceland	MX	Mexico	US	United States of America
CA	Canada	IT	Italy	NE	Niger	UZ	Uzbekistan
CF	Central African Republic	JP	Japan	NL	Netherlands	VN	Viet Nam
CG	Congo	KE	Kenya	NO	Norway	YU	Yugoslavia
CH	Switzerland	KG	Kyrgyzstan	NZ	New Zealand	ZW	Zimbabwe
CI	Côte d'Ivoire	KP	Democratic People's Republic of Korea	PL	Poland		
CM	Cameroon	KR	Republic of Korea	PT	Portugal		
CN	China	KZ	Kazakistan	RO	Romania		
CU	Cuba	LC	Saint Lucia	RU	Russian Federation		
CZ	Czech Republic	LI	Liechtenstein	SD	Sudan		
DE	Germany	LK	Sri Lanka	SE	Sweden		
DK	Denmark	LR	Liberia	SG	Singapore		
EE	Estonia						

IMPROVED SYSTEM FOR DOWNLOADING AND REPORTING
MEDICAL INFORMATION

5

BACKGROUND OF THE INVENTION

Medical Monitoring Devices

10

Various medical monitoring devices exist that download medical measurement data from a remote location to a central location. Such systems require a specialized interface to connect the device to a communication system such as the public telephone system or a pager information system.

15

20

For example, the AIRWATCH respiratory function monitor, described in U.S. Patent Application No. 5,549,117 ("the '117 patent") filed May 23, 1994 and assigned to the assignee of the present application, is a hand-held respiratory monitor that stores a binary file including information relating to respiratory parameters. When the AIRWATCH is connected to a telephone line a connection is automatically established to a central database and the encoded file is modulated by a software modem into analog signals which are transferred to a modem at the central site. The central modem demodulates the signals and generates a file which is processed at the central location and used to update a database.

25

30

Other medical devices include interface software and hardware connections to a personal computer. The computer can then be used to communicate with the central database utilizing a modem.

35

Additionally, as more monitoring devices are utilized in a patient's home, various devices could be located in different rooms or locations. Accordingly, the problems of interfacing to the central database are compounded.

The remote connection of medical devices, such as the AIRWATCH, via the public telephone lines presents problems when such devices are to be used worldwide. The binary

medical information file may include information related to glucose levels, blood pressure, etc. The public telephone systems of various countries are not standardized so different models would have to be built for different countries thereby increasing the overall cost of manufacturing the devices. Since low cost is critical to encourage widespread use of such devices, the lack of telephone system compatibility is a serious problem to the internationalization of the technology.

Additionally, each device generally includes a front end to communicate results of a measurement to the user of the device, e.g., a patient or health care provider. Typically, a front end includes LEDs, a alpha-numeric display, synthetic voice output, etc. The device may be coupled to a personal computer which would execute special software to operate as a front end.

Report Distribution System

A system for generating and distributing medical reports from a central database is described in the above-referenced patent application. Various formats including graphs and tables are described. Typically, these reports are delivered by fax, mail, or e-mail. However, none of these delivery systems facilitate real-time access of medical records by a requestor.

SUMMARY OF THE INVENTION

In one aspect of the present invention, the world-wide-web (WWW) is utilized to provide an enhanced interface to a medical monitoring device. Information from the device is communicated to a personal computer executing standard web browser software. A common gateway interface (CGI) form or applet, executed by the web browser software, receives the communicated information and functions as the front end of the device. Thus, a high-resolution personal computer display can be utilized as the front end of an inexpensive medical device. A result page generated by web server functions as the display of the medical measurement device. Additionally, the web page includes applets for controlling the device according to

standard input, e.g, via mouse or keyboard, which is processed by the result page.

According to another aspect of the invention, medical reporting devices in different locations can be connected utilizing a home health-care bus in the form of the "Universal Serial Bus" (USB).

According to another aspect of the invention, a serial ID code is transferred to a remote database server. The database server responds to the code by providing data associated with the code. User specific data accessed by the ID code is utilized to format the response for the particular user.

Other features and advantages of the invention will be apparent from the following detailed description and appended drawings.

BRIEF DESCRIPTION OF THE DRAWINGS

Fig. 1A is a schematic diagram of a first preferred embodiment of the invention;

Fig. 1B is a block diagram of a personal computer;

Fig. 2 is a flow-chart depicting the steps for using a web browser as a front end of a medical measurement device;

Fig. 3 is a schematic diagram depicting a home health-care bus;

Fig. 4A is a schematic diagram of a medical measurement device that downloads data to a computer through an adapter;

Fig. 4B is a flow-chart depicting the steps of converting a medical information file into a format compatible with a standard input to a personal computer;

Fig. 5 is a diagram depicting a standard keyboard interface;

Fig. 6A is a schematic diagram of an adapter;

Figs. 6B and 6C are diagrams depicting a specific embodiment of an adapter;

Fig. 7 is a flow-chart depicting the steps of transferring a compatible medical information file over the internet;

Fig. 8 is a schematic diagram of a system for transferring medical reports over the internet; and

Fig. 9 is a flow-chart depicting the steps of transferring medical reports over the internet.

5

DETAILED DESCRIPTION OF THE PREFERRED EMBODIMENTS

Fig. 1A is a block diagram of a preferred embodiment of a virtual front end utilizing standard web-browser software. In Fig. 1A, a medical device 10 includes an infrared (IR) transmitter for transmitting medical measurement data, modulated onto an IR carrier, to the IR input of a personal computer 30. In the following the term personal computer will be utilized to refer to any device, such as WebTV or other web appliances, that can be used to access the internet. The transmitted medical measurement data is transmitted in the form of keyboard data (as described more fully below) before being modulated onto the IR carrier. The IR transmitter and IR keyboard interface are standard, well-known parts and are not part of the present invention. The IR keyboard interface directly serves a variety of input devices such as, for example, a keyboard, mouse, AIRWATCH, thermometer, range of motion sensors, barcode reader, scale, height measurement, blood pressure cuff, tympanic compliance, mag stripe writer, tag writer, printer, and printer for wrist bands.

25

Fig. 1B is a block diagram of a typical personal computer and connected peripheral devices. The CPU executes programs which may be provided from the hard-disk drive (HDD), floppy-disk drive (FDD), from the serial port, or from other sources. Typically, a computer is connected to the internet via a modem connected to the serial port.

30

The personal computer executes standard web-browser software, e.g., Netscape Navigator, America On Line, or MicroSoft Internet Explorer. The World Wide Web (WWW) is a network for connecting computers via the internet. Typically, a client computer executes a browser application that allows a user to access documents from any site on the WWW. Documents in hypertext mark-up language (HTML) include links to other

35

HTML documents, graphics and sound files, executable applications, etc. In some cases an HTML document includes executable code, or scripts, embedded within the document. In other situations an applet, for example a Java applet, is referenced within an HTML document and downloaded from a server to execute on the client computer displaying the HTML document with the browser application.

Forms may be included in HTML pages. Data is entered into a form through the keyboard and transmitted to a server application utilizing the common gateway interface (CGI). A program resides on the server that receives the information from the form and returns appropriate data. The types of information that can be exchanged includes text data and binary files such as GIF images.

In one embodiment, depicted in the flow-chart of Fig. 2, a front-end home page is displayed by the web-browser. The URL of the front-end home page can be stored as a bookmark or favorite place.

The compatible medical data is accepted by a form included in the front-end home page and transmitted to a server application executing on a host computer 32 (Fig. 1A) using the common gateway interface (CGI). The server application generates a page displaying the test results and transmits the test results page to the web-browser. The web-browser then displays the results to the user.

Alternatively, the compatible medical data can be input to a Java applet executed by the browser software. The Java applet formats a results image which is displayed by the web-browser. In the interest of security, the I/O of a Java applet is restricted. For example, Java applets cannot read or write files on the client computer executing the applet. Additionally, the browser application limits an applet's network connectivity. An applet's network connectivity is currently limited to its host machine. However, a Java applet can input keyboard data entered through the keyboard of the client machine.

Regardless of whether the results page is generated by the server or a Java applet, the results page can include a

hot link to the web page of a personal physician or other health-care provider. By clicking on the link the results of a medical measurement is transmitted over the internet to the physician's computer 34 (Fig. 1A). A internet link between the computers 30 and 34 of the patient and physician facilitates real time-health care monitoring. For example, after reviewing the results of a measurement the physician might suggest retrying the measurement under the same or different conditions.

Additionally, as depicted in Fig. 1A and described more fully below, the compatible medical data can be transmitted to the central database 36 (Fig. 1A) utilizing the CGI or a Java applet. The compatible medical data is received at the server 32 which decodes the compatible medical data and transfers the decoded data to a central database 36 which integrates the decoded data into the database 36.

In Fig. 1A, a device utilizing an IR transmitter is depicted. If the device were in a different room than the user's computer then the device could not transmit data because IR transmission is limited to line-of-sight. Accordingly, if the device were heavy or immobile, such as a scale, or if multiple devices were located throughout the home an IR interface to the computer would not be practical.

However, as depicted in Fig. 3, various medical measurement devices throughout the home can be connected to a home healthcare bus. In a preferred embodiment, information from each device 10A and 10B is coupled to the home wiring system 300 and is transmitted to a data center 302 via the wiring system. The data is transmitted over the home wiring system utilizing interfaces well-known in the art. Alternatively, special wires, cable, IR repeaters, radio-frequency, or fiber could be utilized to form the bus. The data center 302 includes an interface, for example an IR transmitter, for providing encoded keyboard data to the personal computer.

Alternatively, the medical devices, web appliance, telephone, and other peripheral are connected to the "Universal Serial Bus" (USB). The USB provides a standard to

merge desktop connections. USB compliant medical monitors 10A and 10B have USB interface connectors, e.g., the type B connector is identical in size to an RJ-11 socket. The monitors are connected directly to any USB computer or web appliance through a generic cord.

As described in the above-referenced '117 patent, the medical measurement device may be interfaced to a telephone line via a reporter device which formats measured data and interfaces with the central database. In the USB embodiment, the reporter may function in two modes.

In a first mode, the monitor downloads measurement data and the reporter interfaces with the central database through the USB bus. In the second interactive mode, the reporter establishes a live connection between the monitor and central server. This allows the reporter to be generic and the server to interrogate the monitor directory. The reporter does not need to know anything specific about the particular connected monitor and the server can then be continuously extended to talk to new devices without changing the reporter.

The device of Fig. 1A outputs medical information data encoded as keyboard data which can be received by the keyboard interface of the personal computer. Thus, the medical device could generate medical measurement files in format compatible with a keyboard or other PC input port. Alternatively, medical information data in binary or any other incompatible format could be output by the device to an adapter. The adapter is designed to convert the data output by the device to encoded keyboard data which can be received by the keyboard interface of the computer. A system utilizing an adapter will now be described. In the following the adapter is a stand-alone device which is connected to the output of the medical measurement device. Alternatively, the adaptor could be integrated into the device.

Fig. 4A is a system level diagram of another preferred embodiment of the invention. In Fig. 4A, a medical monitoring device 10 outputs a binary medical information file. As described below, this file may be in the form of

analog signals modulated on a carrier frequency or as a digital signal output by a digital interface.

In addition to the binary medical information file, each device outputs a unique serialized identification code.

5 The operation of the system will now be described with reference to Fig. 4A and flow chart of Fig. 4B. The binary file is transferred to an adapter 400 which receives the binary file and converts the file into a compatible
10 medical file in a format that may be processed and decoded by the standard keyboard interface of a personal computer 30. In the compatible medical file each byte of the medical file is replaced by a scan code comprising ASCII characters which are written to a keyboard buffer as an compatible medical
15 information file. Thus, there is a correspondence between words in the binary medical file and ASCII characters which are stored in the keyboard buffer.

 The patient's personal computer 30 is connected to the World Wide Web on the Internet and executes a browser application. An applet or CGI form, invoked by the browser
20 application, reads keystroke ASCII codes from the keyboard buffer and transfers the ASCII codes to a server application. The server application processes the received ASCII codes to reconstruct the original binary medical file which is then processed by software at the server to generate a result page
25 to be displayed by the PC 30 or to store the received medical information in a database 36.

 The result page generated by the server can be formatted to function as an enhanced user interface. For example, the AIRWATCH (described above) includes an LED
30 interface for displaying time, date, personal best data, etc., and includes buttons for controlling monitor functions. As monitors get smaller and more complicated the process of controlling each function of the device with small buttons and a small display gets difficult.

35 However, if the monitor is connected to the web, via the USB, for example, then the web server can generate a result page for display on web appliance monitor that includes

formatted display of the monitor output parameters and software buttons for controlling the monitor function.

As an example, for the AIRWATCH, the personal best and other data are displayed one at a time. The right and left buttons move to the next digit to the right or left. In an enhanced interface the entire line of parameters would be displayed stretching across the result page. With the standard mouse and keyboard interface any digit could be selected directly and a pop out list used to select the desired value.

Once a monitor is connected to the web, the ID code is provided to the server and functions as a hardware key allowing access to the data on the server associated with that device.

The server responds to the ID by checking user-specific data which describes attributes of the user such as age and native language. The server formats a response page in a manner appropriate to the particular user. Viewing preferences can be saved and recalled during a subsequent session.

Hardware key recognition can be utilized in connection with conventional typed-in data, such as passwords. If a logging monitor is used by more than one family member a "user selector" indicates to the web application which family member's data is to be displayed.

Similarly, when a connection is established from a doctor's office, the database server recognizes the device and the doctor (by his web login). In this way, the server recognizes whether the connection to the database is authorized, and information is displayed appropriately.

PC Keyboard Controller and ISR

The structure of the keyboard 500 and keyboard interface 510 for a PC is depicted in Fig. 5. This configuration is well-known and will be only briefly described. When a key is pressed, a scan code in the form of ASCII codes unique to the key is generated by the keyboard chip 502 and is serially transferred to the keyboard interface 510 by the

keyboard cable 520. The serial data is converted to a parallel byte so that the scan code can be processed by the microprocessing unit (MPU).

5 The scan codes are received by the PC and translated to ASCII codes utilizing a Keyboard Interrupt Service Routine (ISR) included in the Basic I/O System (BIOS). The ISR is invoked by INT 09 each time a key is pressed and converts keyboard data into information that is useful to the system. This conversion results in the Keyboard ISR placing a two-byte
10 character code into a keystroke buffer in the PC's memory.

Typically, the keyboard ISR in a PC/AT system converts the codes received into System Scan Codes. These System Scan Codes are then compatible into the two-byte character codes having a low-order byte, called the main byte,
15 and a high-order byte, called the auxiliary byte. The ASCII value of a key-stroke (if any) is always contained in the main byte and the scan code as the auxiliary byte. When a key, such as a function key, edit key, or function key combination, does not have an ASCII value, then the Keyboard ISR sets the
20 main byte to 00h and the auxiliary byte to a special key value.

A BIOS Keyboard Device Service routine provides an interface through which the operating system or application software can interface with the keyboard buffer.

25

The Adapter

Fig. 6A is a block diagram of the adaptor 400 which includes a device interface 402, processor 410, and serial interface 420. If the medical device 10m utilizes a modem to
30 output a modulated carrier signal encoding the binary medical file then the device is connected to a modem interface in the device interface 402. If the medical device 10s has a serial output then it is connected to a serial interface in the device interface 402. A specific device interface 402 may
35 have either a modem, serial interface, or combination of the two.

A processing unit 410 converts the words of the binary medical information file to scan codes and transfers

the scan codes to the keyboard serial interface 420. The conversion of the words in the binary medical information to scan codes is accomplished utilizing standard techniques, e.g., a look-up-table.

5 The keyboard serial interface 420 transfers the scan code serially to the keyboard controller on the PC as described above. The keyboard serial interface 420 is a pass-through connection that passes the output from the connected keyboard to the PC when a medical device 10 is not
10 connected to the adapter.

A specific embodiment of a prototype adapter 600 is depicted in Figs. 6B and 6C. In Fig. 6B a device having an output modulated by a modem is coupled to the adapter 600 through a standard RJ-11 jack. A telephone simulator couples
15 the binary medical file to an HP Palmtop computer through a PCM-CIA modem 620. A wedge circuit controllably couples either the keyboard or Palmtop output to the PC.

The operation of the adaptor 600 will now be described for the case where an AIRWATCH respiratory function
20 monitor is coupled to the adaptor. The data interface to the AIRWATCH specifies a 5 byte serial number, a packet list including a header, 128 bytes of packet data, and 2 bytes of CRC (cyclic redundancy checking).

The adapter 600 auto-answers AIRWATCH initiated
25 downloads and sends the AIRWATCH data over the IBM PC keyboard port as if typed on a "virtual" keyboard. Each byte of the AIRWATCH data is converted to 2 ASCII hex nibbles. Thus, for example a byte having hex value 0x1A is represented as if the two-character ASCII string "1A" was typed on the keyboard. In
30 this embodiment the adapter 600 does not perform any CRC or error checking, it simply converts and passes along data that it receives.

As described above, the I/O options of Java applets are limited by security considerations. One such limitation
35 is that the Java output cannot output data through the keyboard interface. For medical devices requiring an acknowledge signal or other handshaking, the adapter is not able to provide the required information. Accordingly, the

server application can display an acknowledge which must be provided to the device by the user.

Internet Transfer of Medical Records

5 Referring to Figs. 1 and 7, a process for transferring medical information from a medical measuring device to a central database 36 will now be described. Referring to the flow-chart of Fig. 7, a browser application, running on the user's computer, utilizes a designated URL to
10 access a data transfer page over the internet. As described above, the designated URL may be automatically provided when a medical device 10 is coupled to the adapter 20.

 The data transfer page includes an embedded data transfer applet, which in a preferred embodiment is a Java
15 applet. The applet is executed on the user's computer and inputs the converted medical file from the keyboard buffer and transmits the file to the host computer 32.

 Alternatively, as described above, the data transfer page can include a form that transmits converted medical data
20 to the host 32 utilizing the CGI.

 The host computer decodes the converted medical file to change the ASCII codes to corresponding bytes of the medical information file. Preferably, the medical information file is in a form that is processed by database software to
25 update the medical database 36.

Internet Delivery System

 A system for utilizing the internet to deliver medical reports in real-time will now be described with
30 reference to Figs. 8 and 9. Typically, the reports are computer generated from records in a central database and are formatted either as text or graphics files. Additionally, the reports can be formatted as faxes, letters, etc. An example of a central database is described in the '117 patent and
35 includes information downloaded over the telephone system from AIRWATCH devices.

A report requester utilizes a browser executing on a client computer 30 to access a report request page by supplying a designated URL.

5 The host computer 32 generates a report request HTML document including a FORM to allow feedback from a client computer 34 displaying the report request document using a browser application.

10 The report requester enters passwords for accessing a particular patient's records. The requestor also indicates the desired format of the report, e.g., a graph, table, or other format. When the requestor completes filling out the form the information entered is transferred to the form reporting server application executing on the host computer 32 utilizing the common gateway interface (CGI).

15 The form reporting server application invokes a report delivery script which first checks the codes to confirm that the requester is authorized to access the records. The script then invokes report generating software which generates a report file.

20 If the report file is a text file then the report delivery script converts the file to an HTML report file and transfers the report file to the client computer to be displayed by the browser application. If the report file is a graphics file it is converted by the report delivery script
25 into a graphics file type that can be displayed by the browser or a browser helper application or plug-in and transfers the compatible graphics report file to the client computer to be displayed by the browser application.

30 In a preferred embodiment, the report files are Postscript® files which are converted by the server report delivery software to .GIF files before transfer to the client computer. Formats of reports are depicted in the above-referenced patent application.

35 Alternatively, an interactive requestor user interface can be implemented utilizing a Java applet.

Thus, physicians, health officials, and other medical personnel have real-time access to database records stored at a central location.

The invention has now been described with reference to the preferred embodiments. Alternatives and substitutions will now be apparent to persons of skill in the art. For example, the keyboard interface of a PC has been described.

5 However, the principles of the invention are equally applicable to other platforms including Macintosh® and UNIX. Further, the preferred embodiment utilizes the WWW. Again, other network implementations are within the scope of the invention. Accordingly, it is not intended to limit the

10 invention except as provided by the appended claims.

WHAT IS CLAIMED IS:

1 1. A system for implementing an enhanced interface
2 for a medical measurement device, said system comprising:
3 a web appliance, connected to a network and
4 including standard I/O ports and a display device;
5 a data input/output interface, coupling the medical
6 measurement device and the web appliance, for transmitting
7 compatible information data, from the medical measurement
8 device, in a digital format compatible for processing by said
9 web appliance and for transmitting medical measurement device
10 control information from the web appliance to the medical
11 measurement device; and
12 a processor included in said web appliance,
13 executing web-browser software to display a front-end page and
14 configured to process said information data provided by said
15 medical measurement device and to display a result page
16 displaying parameter values relating to the operation of the
17 medical device and for displaying interactive function keys to
18 activate functions in the medical device.

1 2. The system of claim 1, further comprising a
2 remote database server coupled to the network, wherein said
3 remote database server receives compatible medical data from
4 said processor, generates said result page and transmits said
5 result page to said processor.

1 3. The system of claim 2, wherein said compatible
2 medical data received by the remote database server includes a
3 device identification data provided by said medical
4 measurement device.

1 4. The system of claim 3, wherein said device
2 identification data is implemented as a hardware key in said
3 medical measurement device.

1 5. The system of claim 2, wherein said compatible
2 medical data received by the remote database server includes a
3 user identification data identifying a specific user.

1 6. The system of claim 5, wherein said remote
2 database server generates said result page in accordance with
3 preferences associated with said user identification data.

1 7. The system of claim 1, wherein said information
2 data provided to said processor by said medical measurement
3 device is input to a Java applet executed by said web-browser
4 software, wherein said Java applet formats said result page.

1 8. The system of claim 1, wherein said digital
2 format is one of a binary data format and a keyboard data
3 format.

1 9. A system for implementing a hardware key for a
2 medical measurement device to gain access to a remote
3 database, said system comprising:
4 a web appliance, connected to a network and
5 including standard I/O ports and a display device;
6 a data output interface, coupled to a medical
7 measurement device, for providing medical measurement device
8 identification data to said web appliance;
9 a remote database server coupled to the network,
10 said database server for providing user data when a
11 identification data associated with a user is received;
12 a processor included in said web appliance,
13 executing web-browser software to display a front-end page and
14 configured to transfer said medical identification data
15 provided by said medical measurement device to said remote
16 database server to gain access to data associated with a user
17 of said medical measurement device.

1 10. A medical information management system for
2 receiving medical information measured by a plurality of

3 medical measurement devices and providing the information to a
4 personal computer, said system comprising:

5 a bus, having a plurality of input/output ports for
6 coupling to one of the medical devices;

7 a web appliance coupled to the bus, with the web
8 appliance executing web-browser software to display a
9 front-end page and configured to process information data
10 provided by said one medical measurement device and to display
11 a result page; and

12 a telephone connector for connecting said one
13 medical device to a remote database.

1 11. The system of claim 10, wherein said bus is a
2 Universal Serial Bus.

1 12. The system of claim 10, wherein said telephone
2 connector includes a reporter device which formats information
3 data from said one medical device and interfaces with said
4 remote database.

1 13. The system of claim 12, wherein said reporter
2 device sends formatted information to the remote database, and
3 wherein the remote database generates said result page and
4 sends said result page to said web appliance.

1 14. The system of claim 12, wherein the reporter
2 device interfaces with the remote database over said bus.

1 15. The system of claim 10, wherein the telephone
2 connector includes a reporter device which establishes a
3 direct connection between said one medical device and said
4 remote database.

1 16. The system of claim 10, wherein said web
2 appliance receives said result page from said remote database.

1 17. The system of claim 10, wherein said web
2 appliance receives said information data provided by said one

3 medical device directly from said one medical device over said
4 bus.

1 18. The system of claim 10, wherein said remote
2 database server receives information data from said medical
3 measurement device, generates said result page and transmits
4 said result page to said web appliance.

1 19. The system of claim 18, wherein said
2 information data received by the remote database server
3 includes a device identification data provided by said medical
4 measurement device.

1 20. The system of claim 19, wherein said device
2 identification data is implemented as a hardware key in said
3 medical measurement device.

1 21. The system of claim 18, wherein said
2 information data received by the remote database server
3 includes a user identification data identifying a specific
4 user.

1 22. The system of claim 21, wherein said remote
2 database server generates said result page in accordance with
3 preferences associated with said user identification data.

1 23. A medical information management system for
2 receiving and processing medical information measured by one
3 or more medical measurement devices, the system comprising:
4 a web appliance executing web-browser software to
5 display a front-end page and configured to process information
6 data provided by the one or more medical measurement devices
7 and to display a result page;

8 communication means for communicably coupling said
9 one or more medical measurement devices to said web appliance;
10 and

11 a remote server coupled to said web appliance over a
12 network.

1 24. The system of claim 23, wherein said
2 communication means includes a Universal Serial Bus.

1 25. The system of claim 23, wherein said
2 communication means includes one of a wire cable, an IR
3 repeater, a radio-frequency interface and a fiber optic cable.

1 26. The system of claim 23, wherein said web
2 appliance receives a medical information data from one of the
3 medical measurement devices and generates the result page.

1 27. The system of claim 23, wherein said web
2 appliance receives a medical information data from one of the
3 medical measurement devices and wherein the web appliance
4 sends the medical information data to the remote server over
5 the network.

1 28. The system of claim 27, wherein the remote
2 server sends the result page to the web appliance over the
3 network for display at the web appliance.

1 29. A system for allowing authorized access to
2 medical information associated with a patient in a remote
3 database, the system comprising:

4 a medical measurement device associated with a
5 patient;

6 a remote database server coupled to a network, said
7 database server for providing user data associated with said
8 patient;

9 a data output interface, coupled to the medical
10 measurement device, for providing medical measurement data and
11 device identification data to said remote database; and

12 a web appliance, coupled to the network and
13 including standard I/O ports and a display, said web appliance
14 executing web-browser software to display said user data
15 wherein said web browser sends a login code to said remote
16 database, and wherein said remote database sends said user

17 data to said web appliance if said login code is associated
18 with said device identification data.

1 30. The system of claim 29, wherein said user data
2 is transmitted to said web appliance as a front-end page, and
3 wherein said front-end page is displayed on the display.

1 31. The system of claim 29, wherein said data
2 output interface includes a reporter device which establishes
3 a direct telephony connection between the medical measurement
4 device and the remote database.

1 32. The system of claim 29, wherein said data
2 output interface includes a reporter device which downloads
3 said medical measurement data and said device identification
4 data, and wherein said reporter device interfaces directly
5 with said remote database.

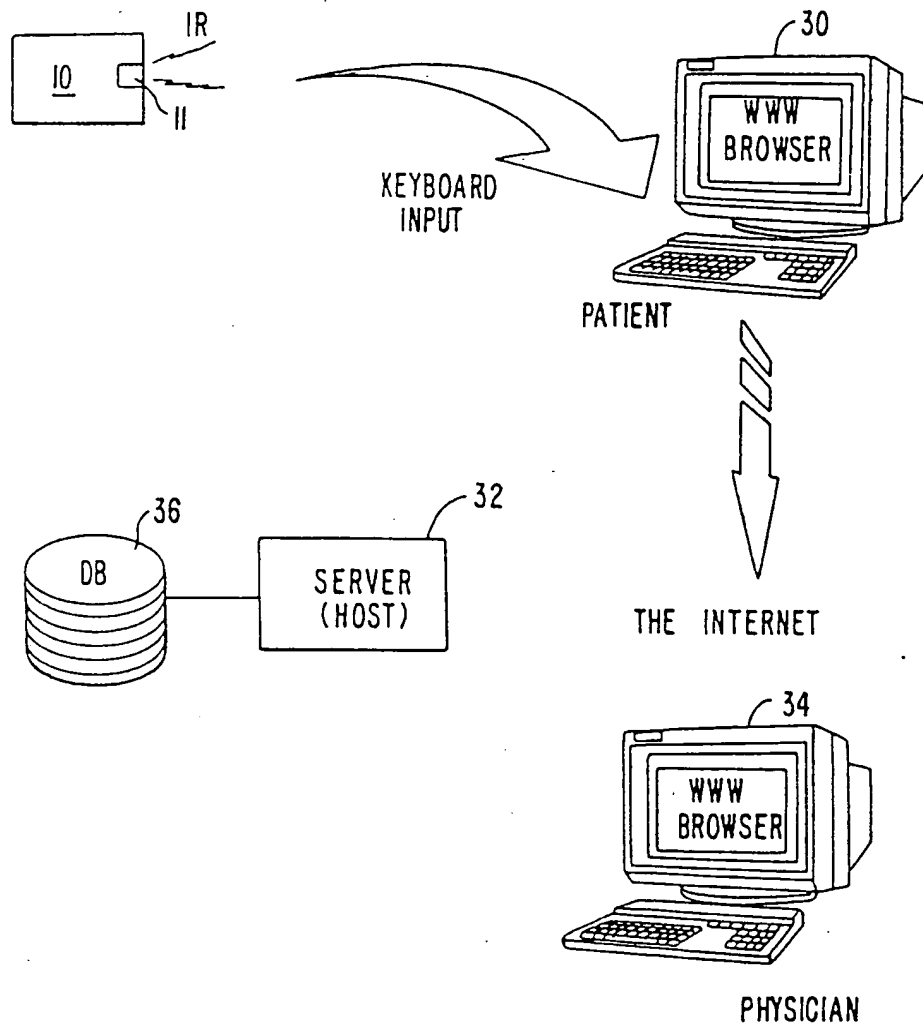

FIG. 1A.

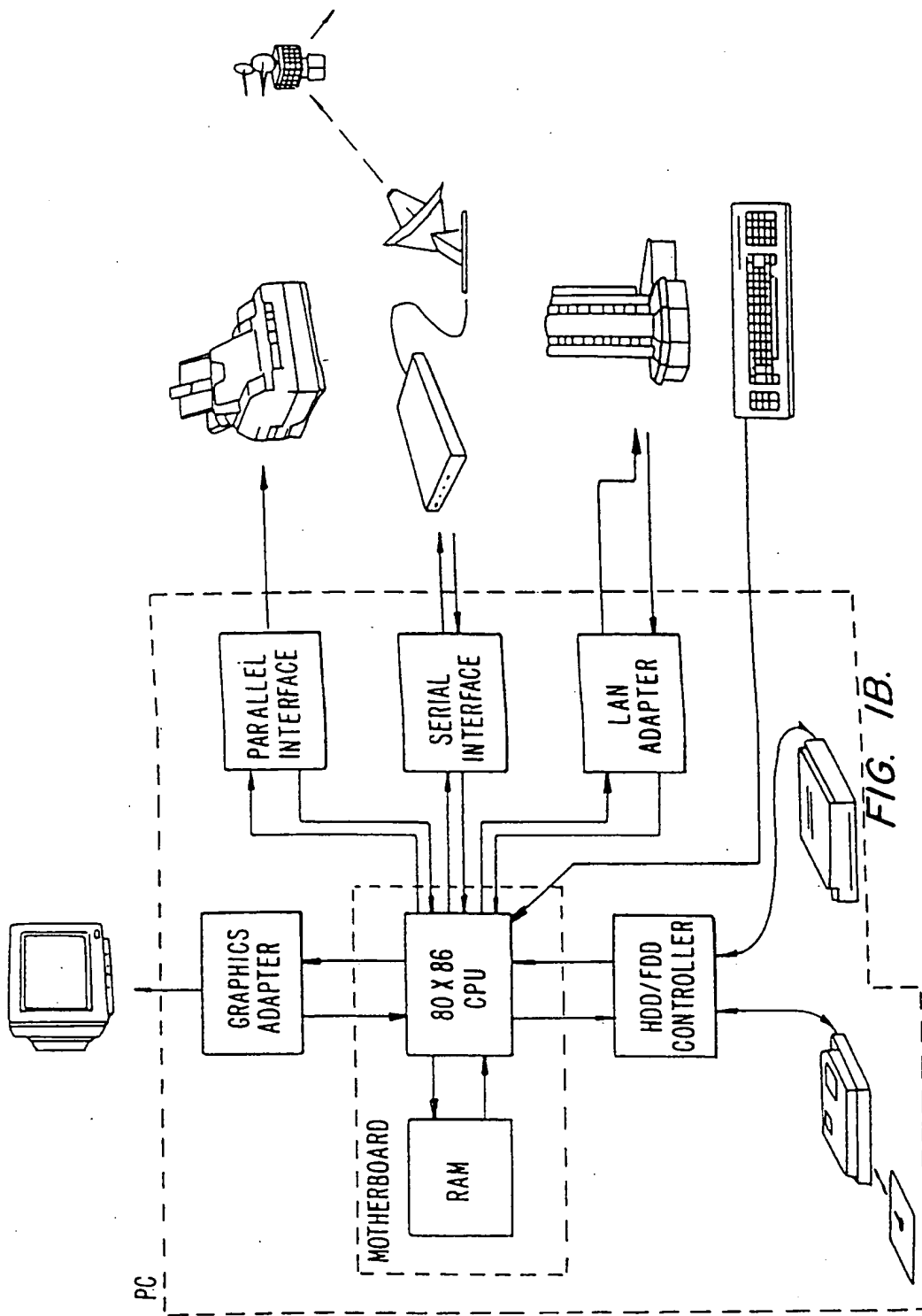

FIG. 1B.

3/11

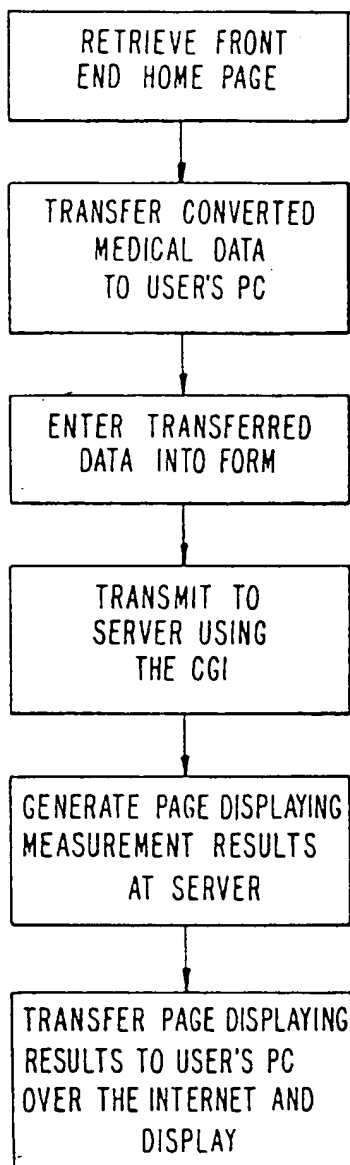

FIG. 2.

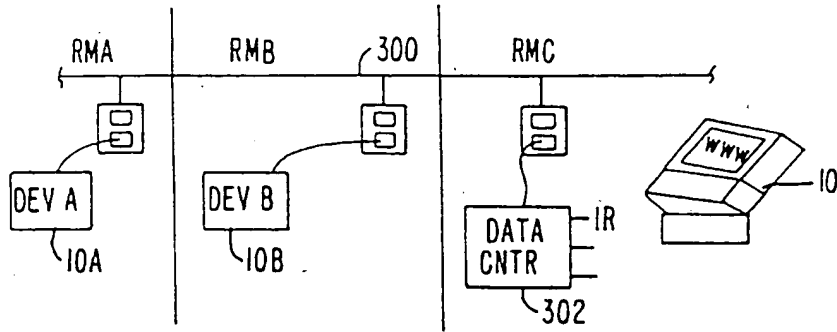

FIG. 3.

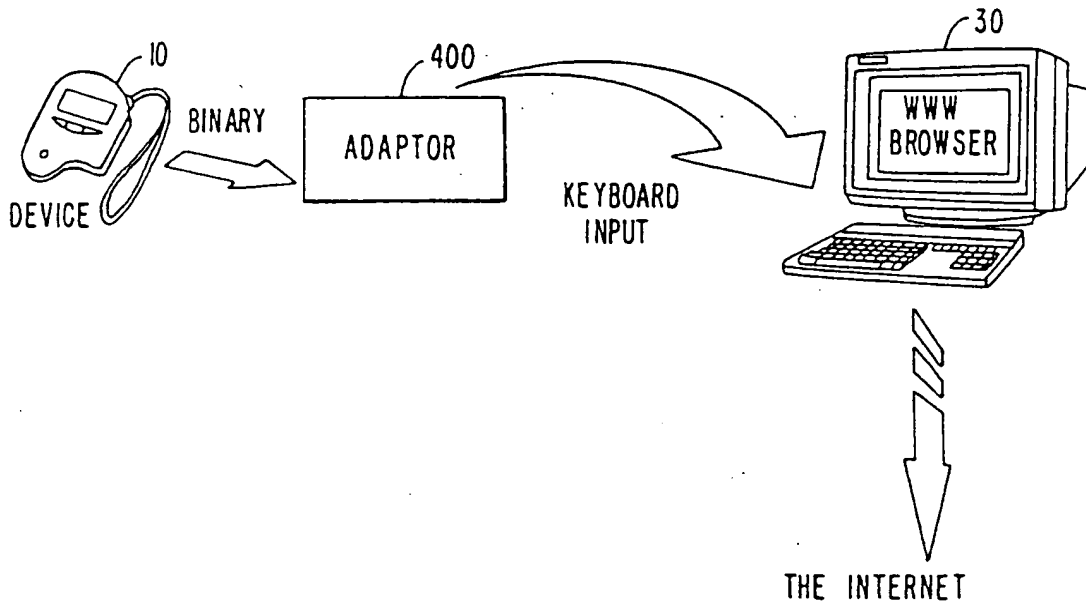
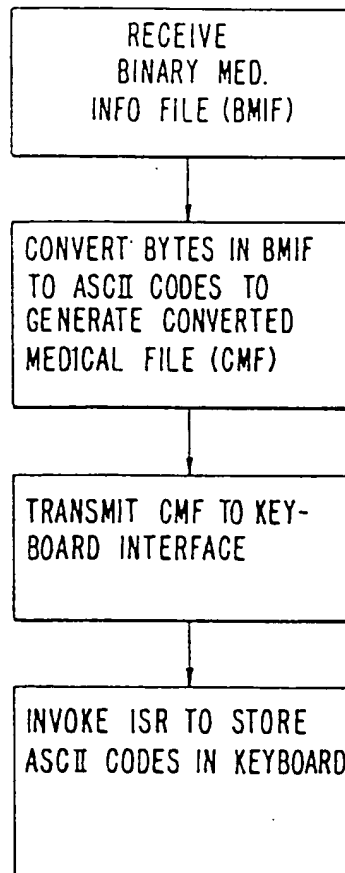

FIG. 4A.

5/11

*FIG. 4B.*

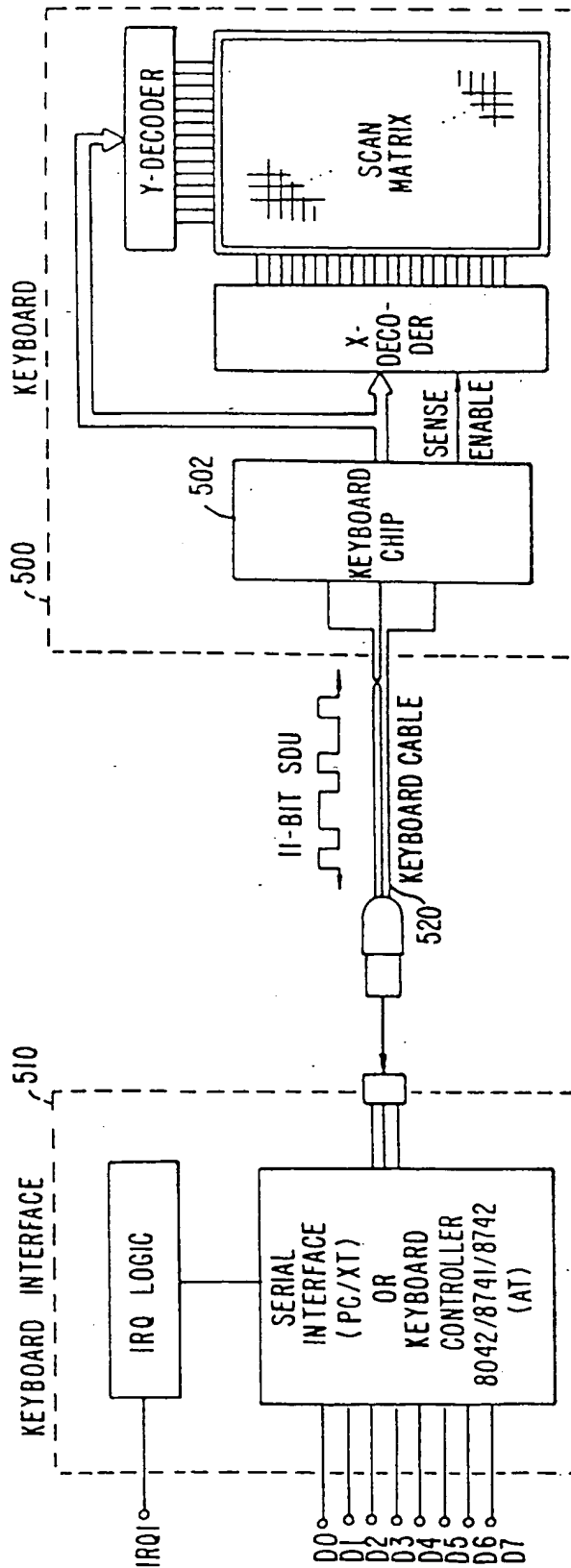

FIG. 5. PRIOR ART

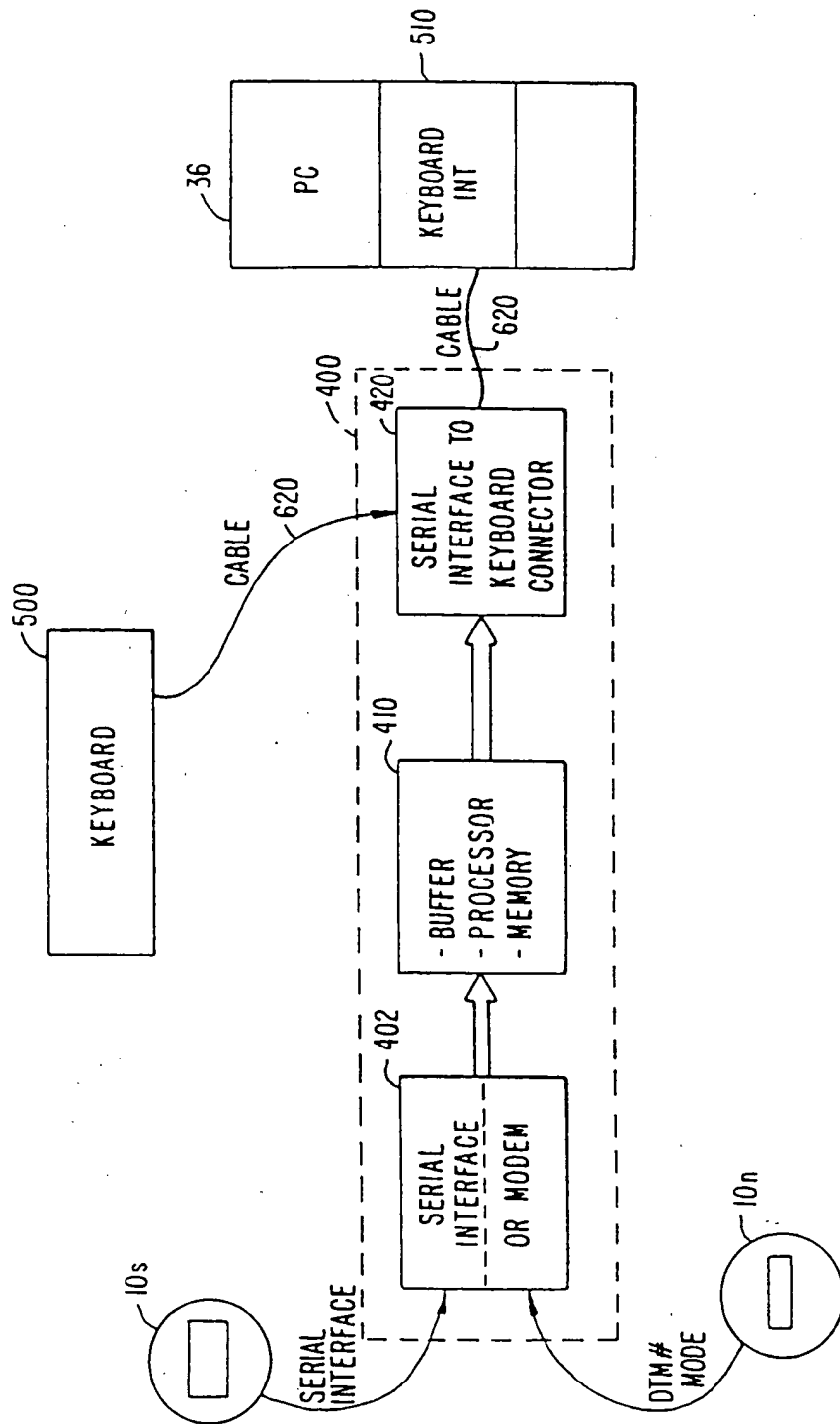

FIG. 6A.

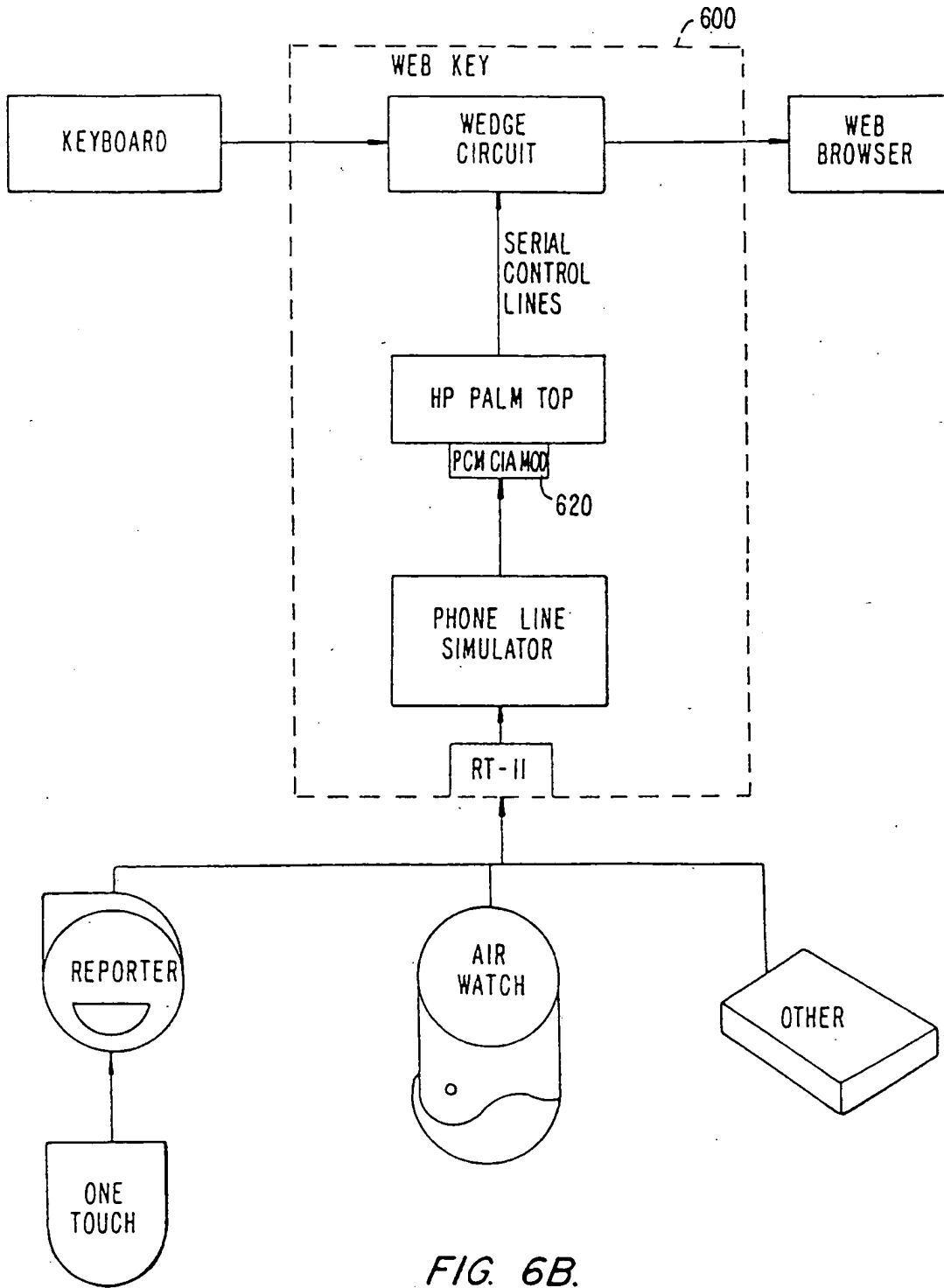

FIG. 6B.

9/11

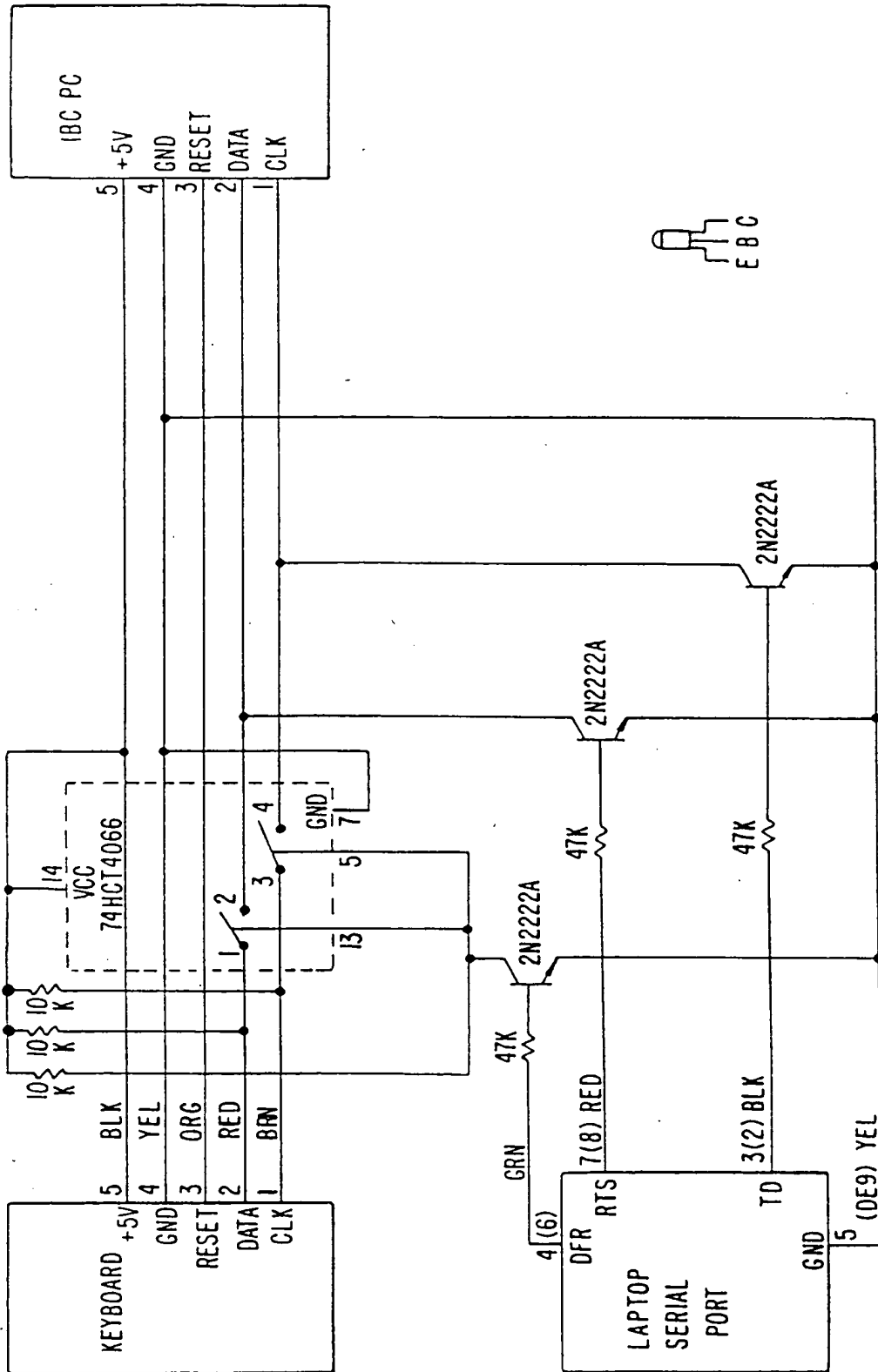
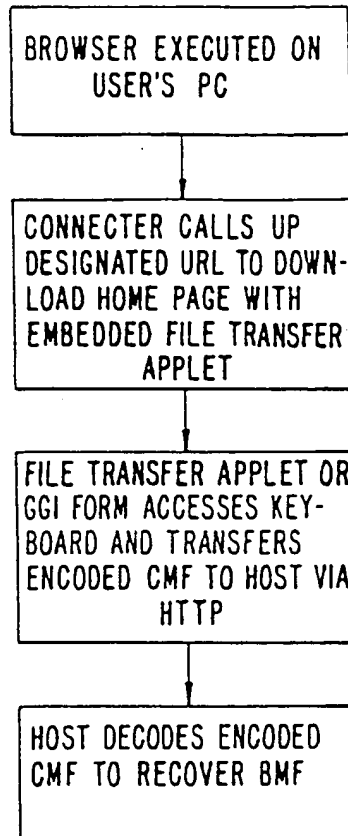

FIG. 6C.

10/11

*FIG. 7.*

II/II

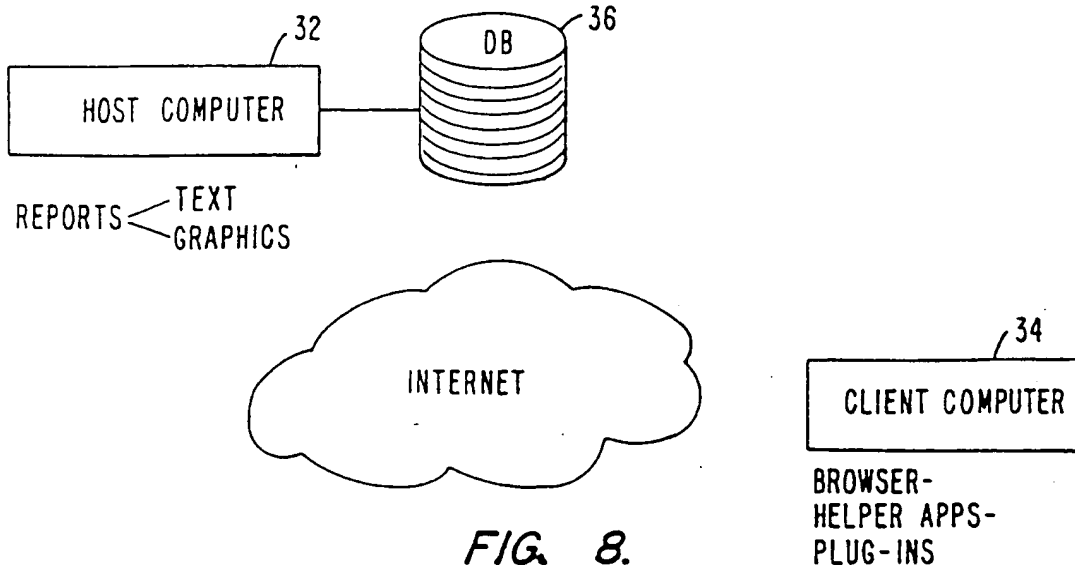

FIG. 8.

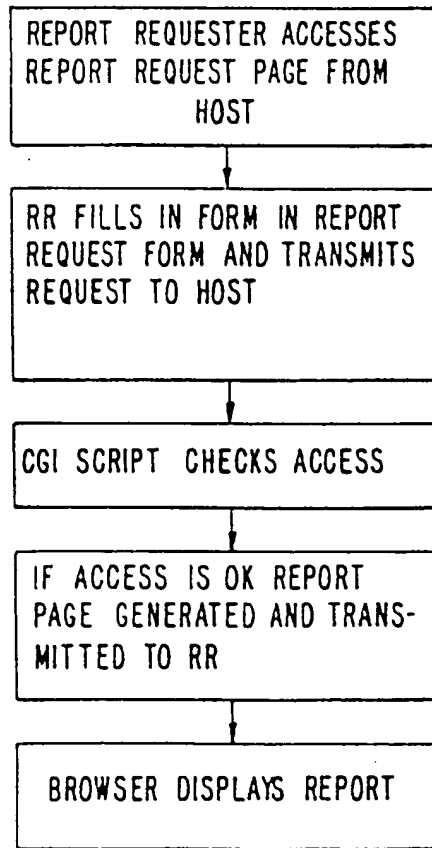

FIG. 9.

INTERNATIONAL SEARCH REPORT

International application No.
PCT/US98/13136

A. CLASSIFICATION OF SUBJECT MATTER IPC(6) :H04M 11/00 US CL :379/38, 600/300, 908 According to International Patent Classification (IPC) or to both national classification and IPC		
B. FIELDS SEARCHED Minimum documentation searched (classification system followed by classification symbols) U.S. : 379/38, 600/300, 908 Documentation searched other than minimum documentation to the extent that such documents are included in the fields searched Electronic data base consulted during the international search (name of data base and, where practicable, search terms used) APS		
C. DOCUMENTS CONSIDERED TO BE RELEVANT		
Category*	Citation of document, with indication, where appropriate, of the relevant passages	Relevant to claim No.
X	US 5,633,910 A (COHEN) 27 May 1997, entire document.	1-3, 5-19, 21-32
<input type="checkbox"/> Further documents are listed in the continuation of Box C. <input type="checkbox"/> See patent family annex.		
* Special categories of cited documents:		
A	document defining the general state of the art which is not considered to be of particular relevance	*T* later document published after the international filing date or priority date and not in conflict with the application but cited to understand the principle or theory underlying the invention
E	earlier document published on or after the international filing date	*X* document of particular relevance; the claimed invention cannot be considered novel or cannot be considered to involve an inventive step when the document is taken alone
L	document which may throw doubts on priority claim(s) or which is cited to establish the publication date of another citation or other special reason (as specified)	*Y* document of particular relevance; the claimed invention cannot be considered to involve an inventive step when the document is combined with one or more other such documents, such combination being obvious to a person skilled in the art
O	document referring to an oral disclosure, use, exhibition or other means	*A* document member of the same patent family
P	document published prior to the international filing date but later than the priority date claimed	
Date of the actual completion of the international search 27 AUGUST 1998		Date of mailing of the international search report 23 SEP 1998
Name and mailing address of the ISA/US Commissioner of Patents and Trademarks Box PCT Washington, D.C. 20231 Facsimile No. (703) 305-3230		Authorized officer <i>Stephen Huang</i> STEPHEN HUANG Telephone No. (703) 308-3399